

■カラー鋼板(ロールフォーミング)

St K型タイプ 働き巾156 mm t=0.5

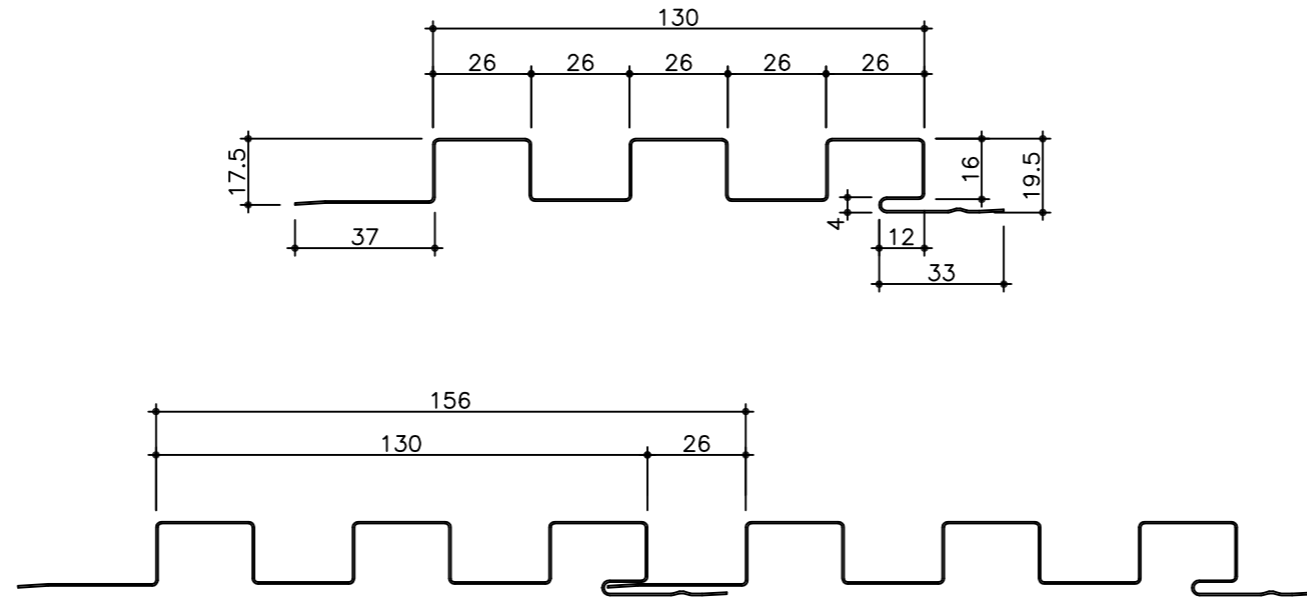

廻り縁 K-101 2m

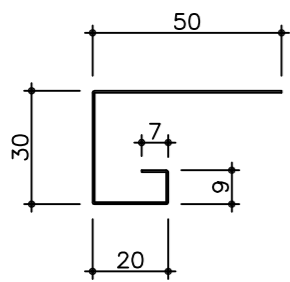

水切 K-202 2m

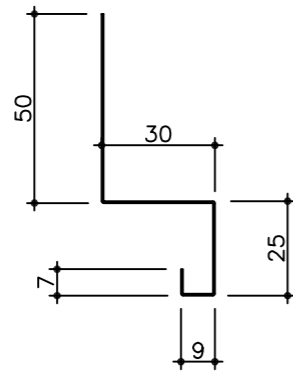

腰水切り C-250 2m

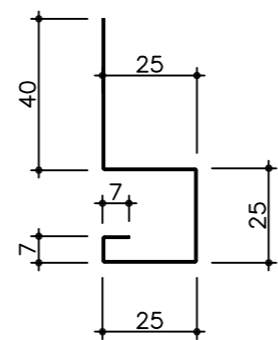

H型接続 K-400 2m

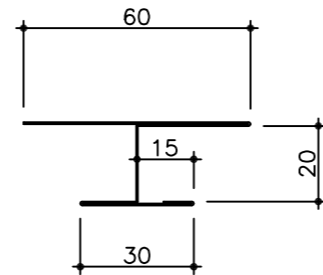

出隅 (K-303)

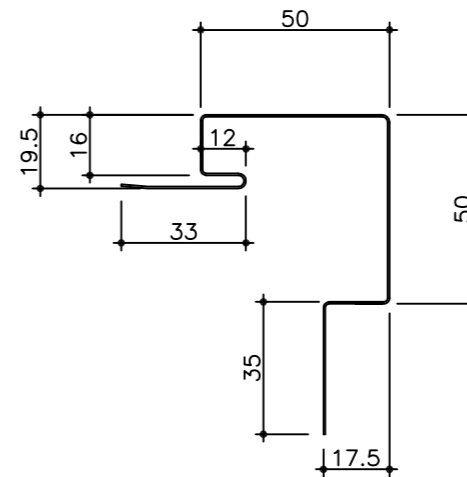

入隅 (K-304)

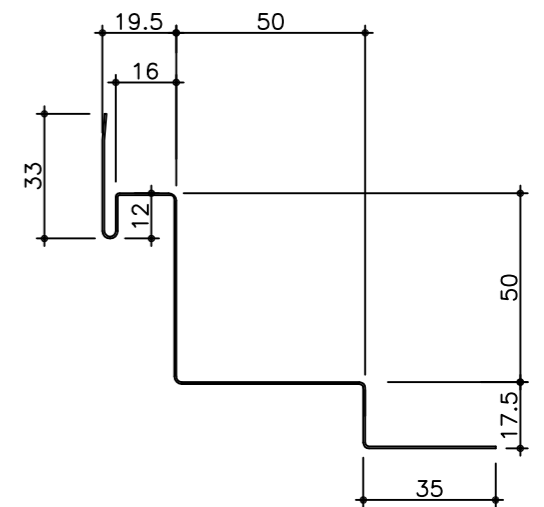

カラー鋼板K型スパン・付属品

St K型タイプ

断面形状寸法図

Scale : 1/2

 難波金属株式会社

■カラー鋼板(ロールフォーミング)

St K型タイプ 働き巾160 mm t=0.8

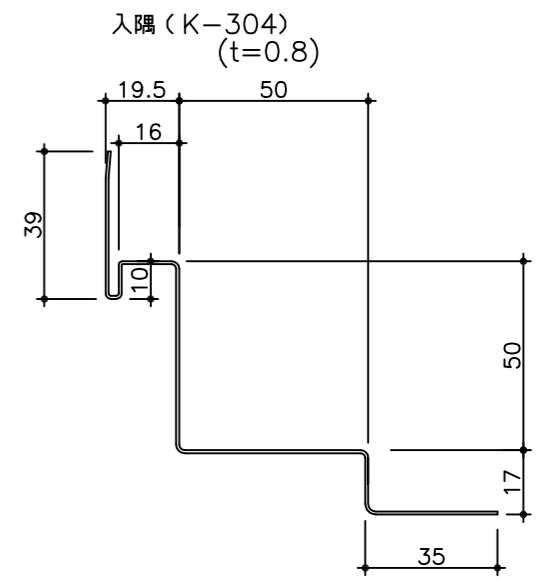
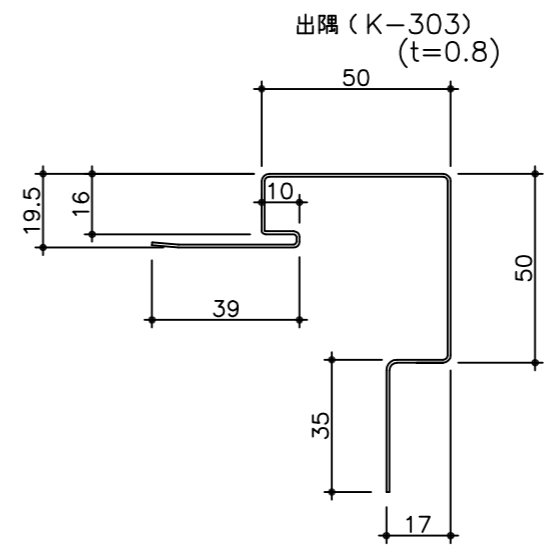
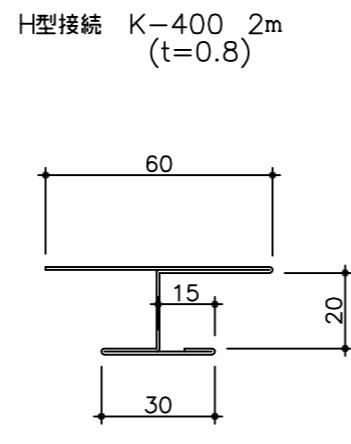
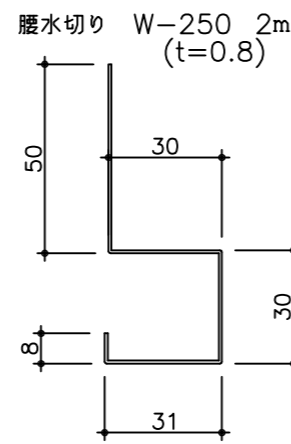
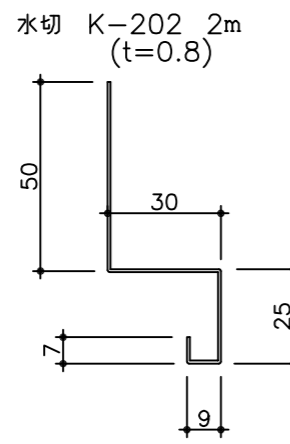
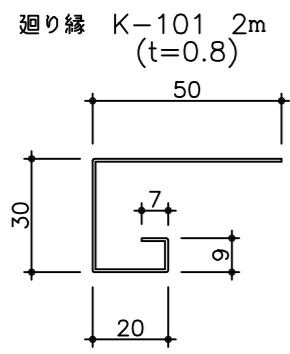
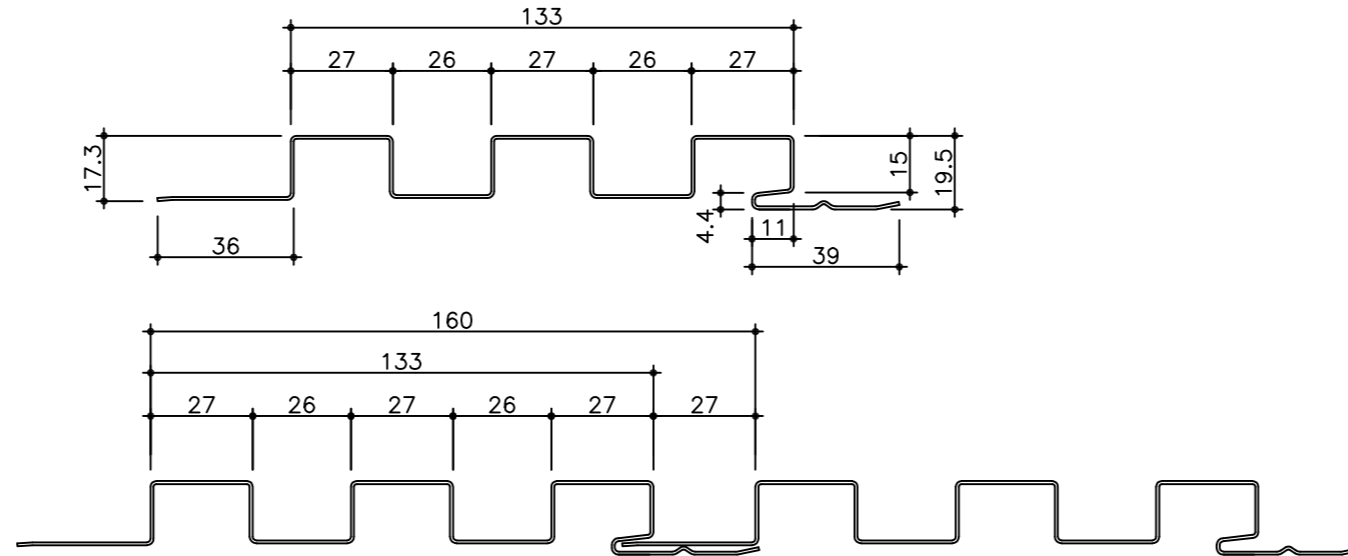

カラー鋼板K型スパン・付属品	
St K型タイプ	
断面形状寸法図	Scale : 1/2
<b>難波金属株式会社</b>	