

■カラーステンレス(ロールフォーミング)

SUS K型タイプ 働き巾156 mm t=0.4

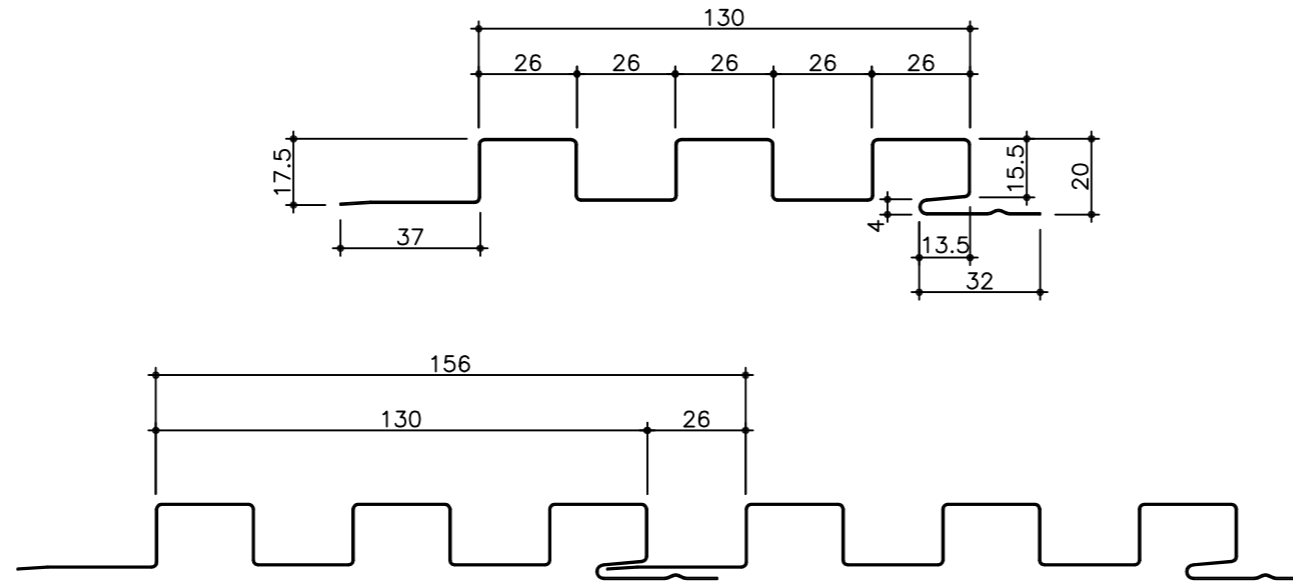

廻り縁 SK-101 2m (0.4t)

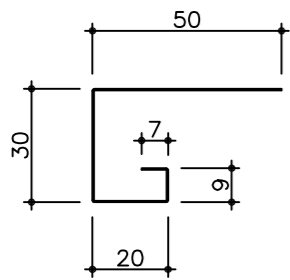

水切 SK-202 2m (0.4t)

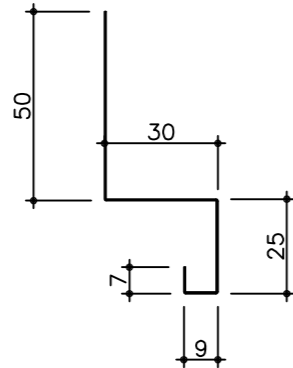

腰水切り SK-250 2m (0.4t)

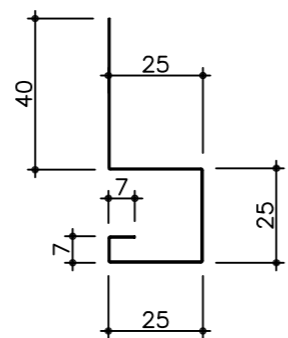

H型接続 SK-400 2m (0.4t)

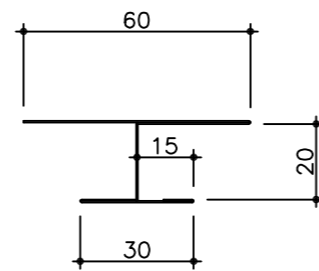

出隅 (SK-303) (0.4t)

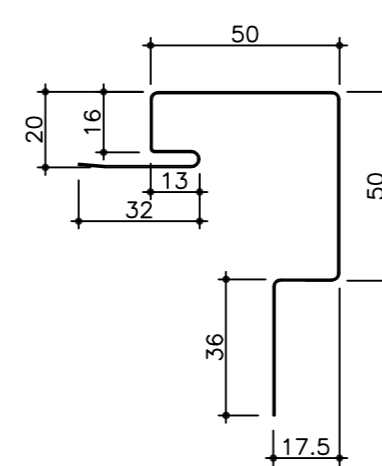

入隅 (SK-304) (0.4t)

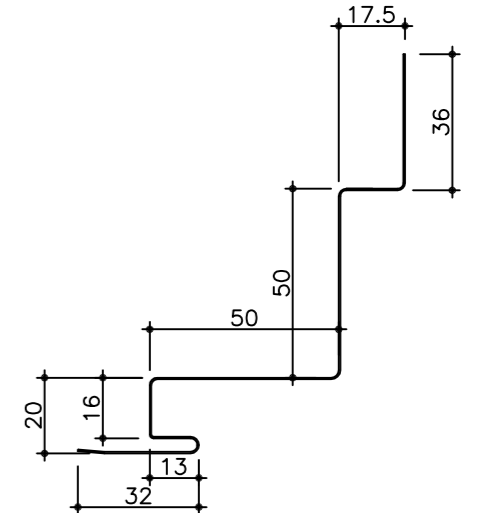

カラーステンレスK型スパン・付属品

SUS K型タイプ

断面形状寸法図

Scale : 1/2

 難波金属株式会社